

令和3年度

図面

工場長	運転係長

業務名 発寒清掃工場焼却設備臨時清掃業務

1	発寒清掃工場配置図			
2	1階機器配置図			
3	2階機器配置図			
4	3階機器配置図			
5	4階機器配置図			
6	5階機器配置図			
7	6階機器配置図			
8	焼却炉断面図			
9	ボイラ水管臨時清掃			
10	排ガスダクト臨時清掃			
11	煙突保護作業			
12	灰押出装置臨時清掃			
13	1階飛散防止養生			
14	3階飛散防止養生			
15	4階飛散防止養生			
16	5階飛散防止養生			



札幌市西区発寒15条14丁目1-1

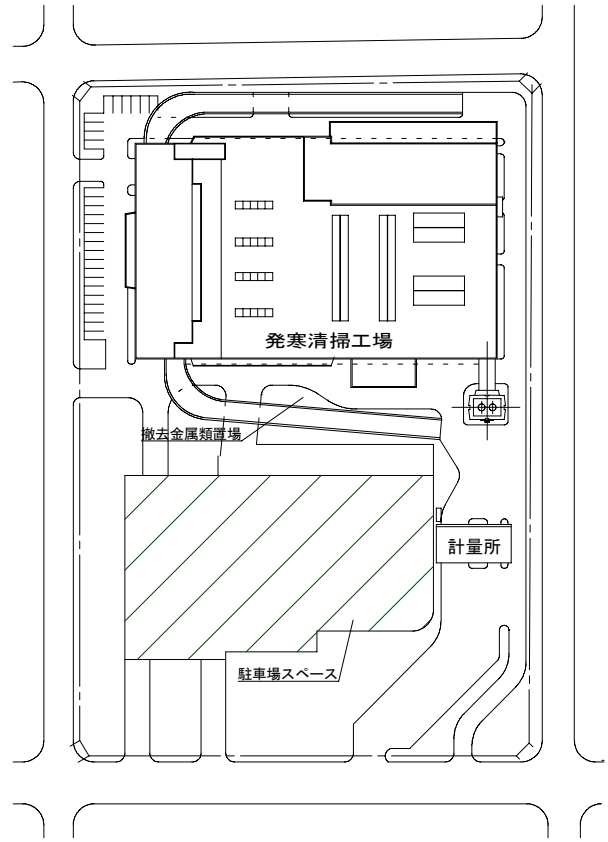
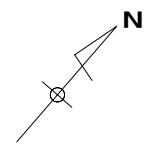
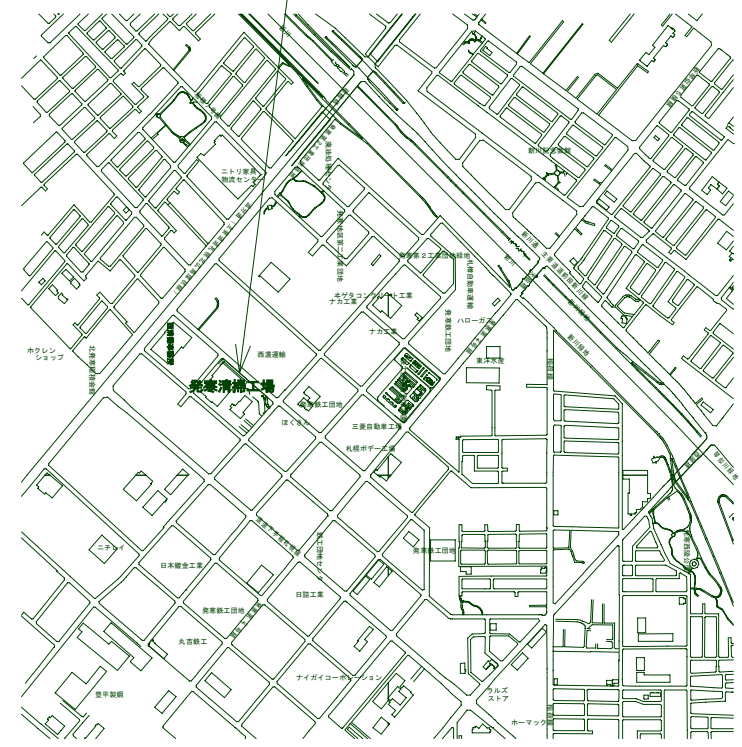

複写禁止

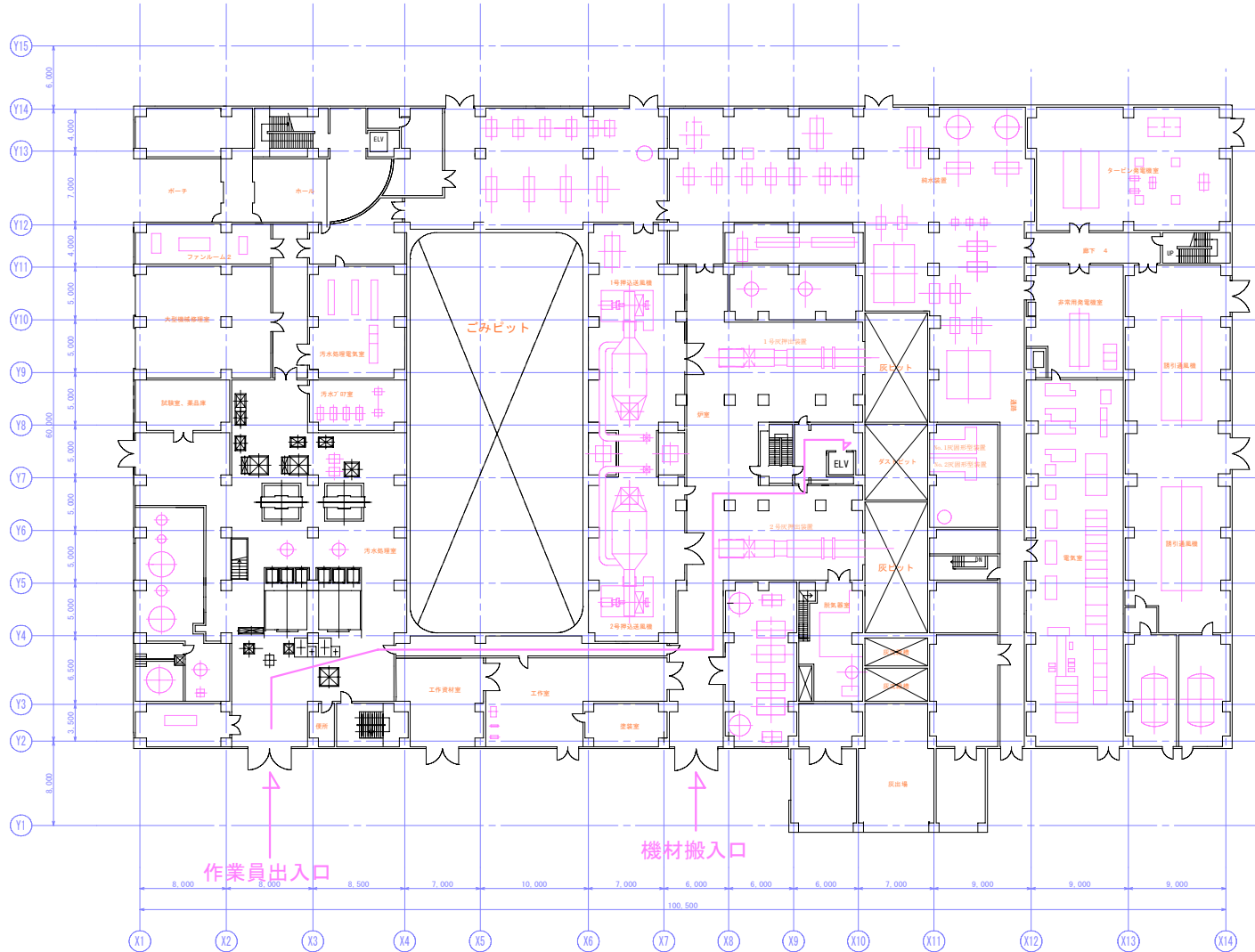
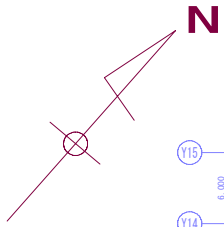

複写禁止

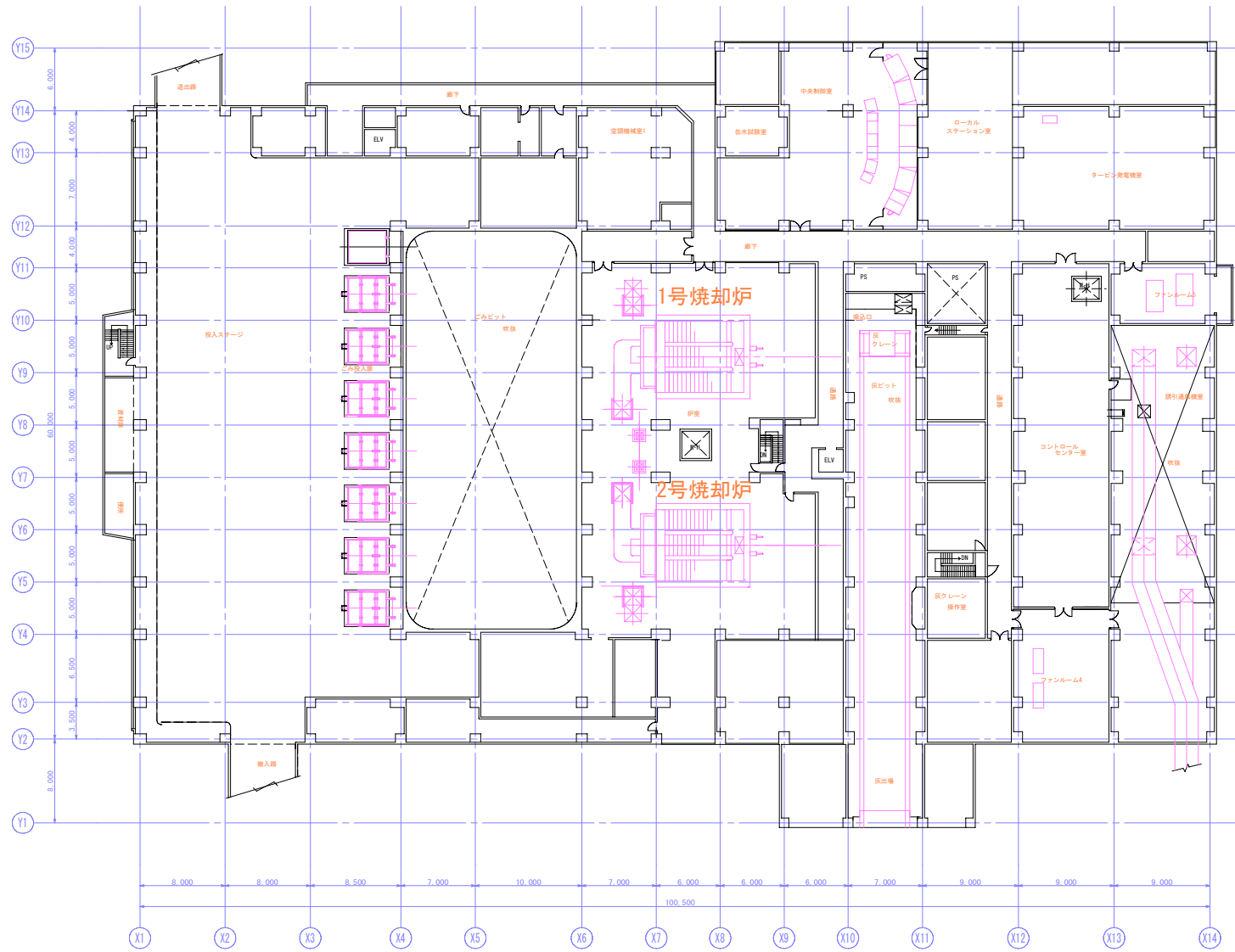
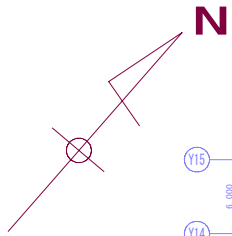

複写禁止

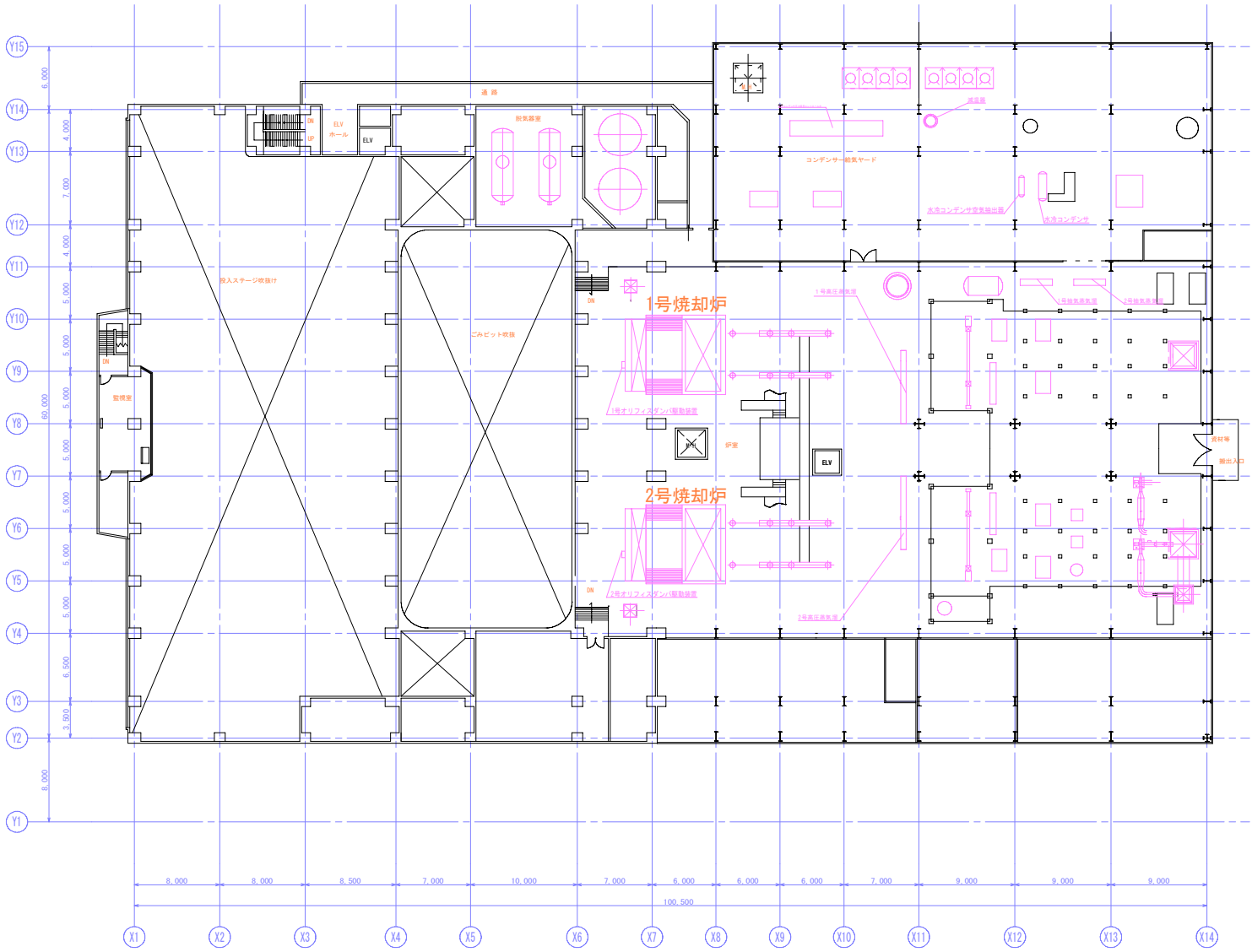
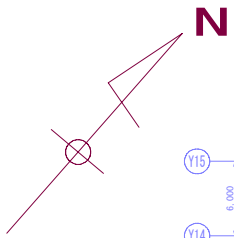

複写禁止

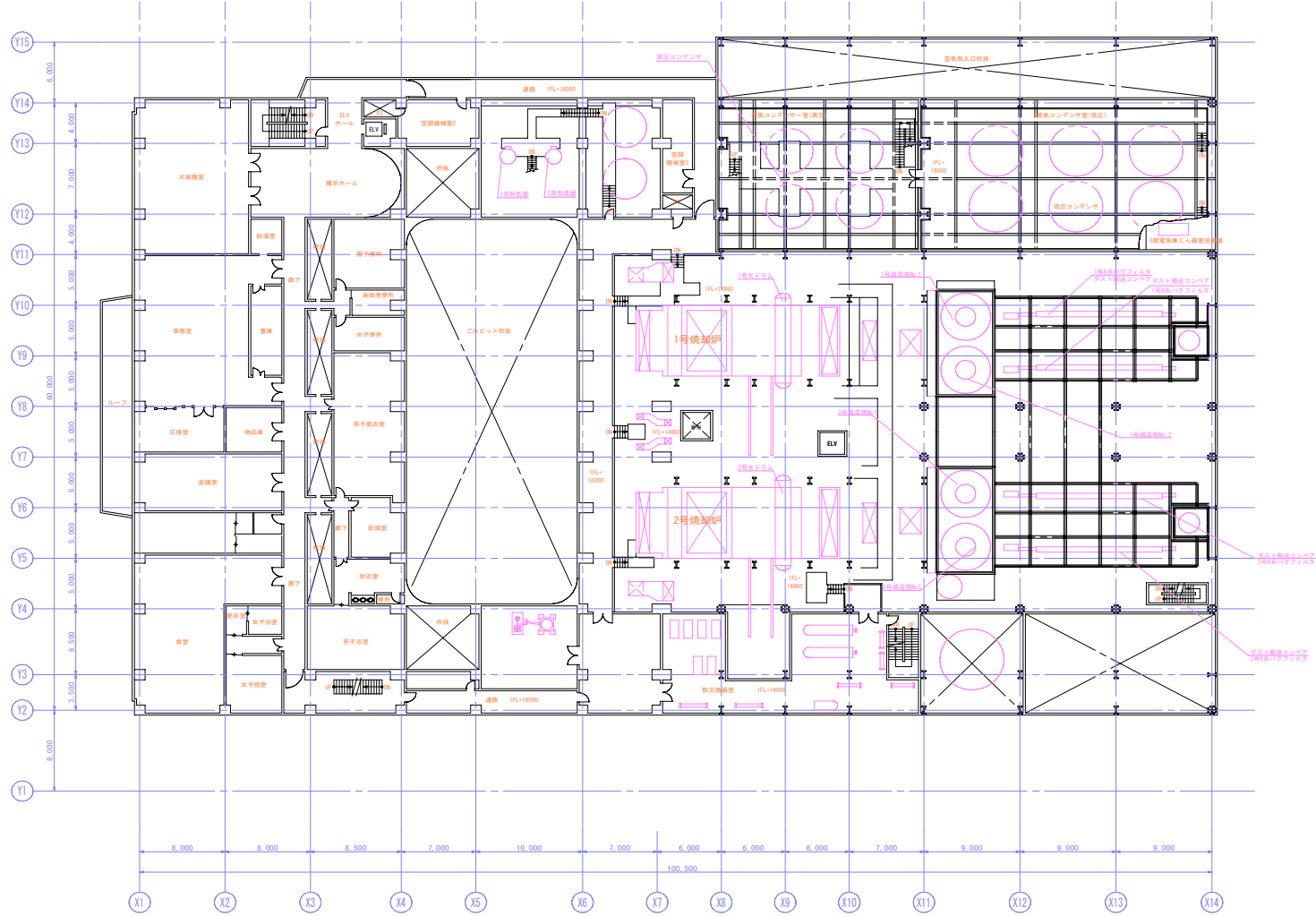
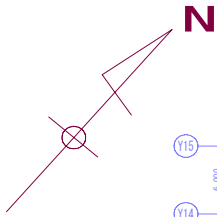

複写禁止

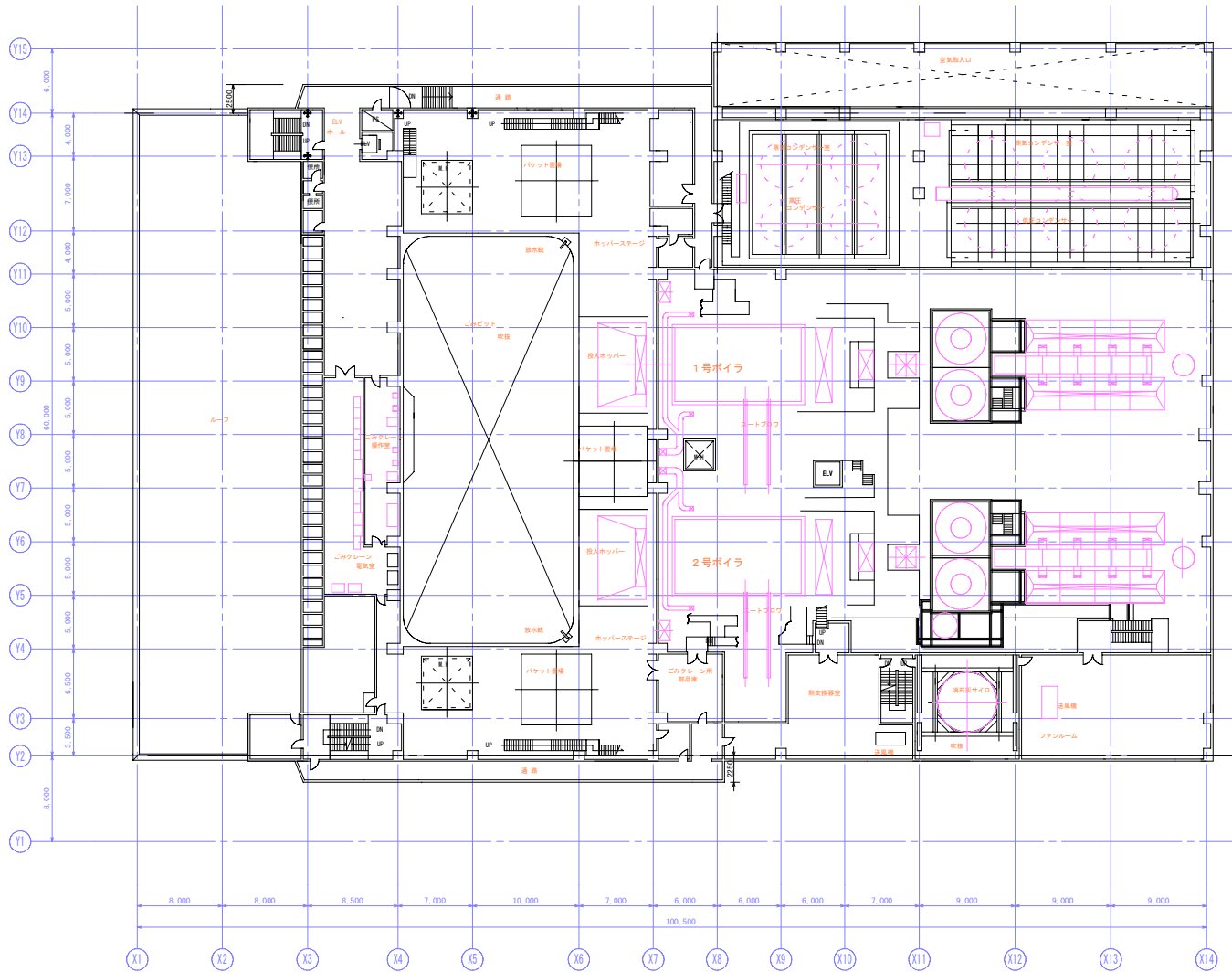
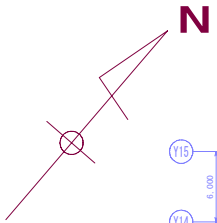

複写禁止

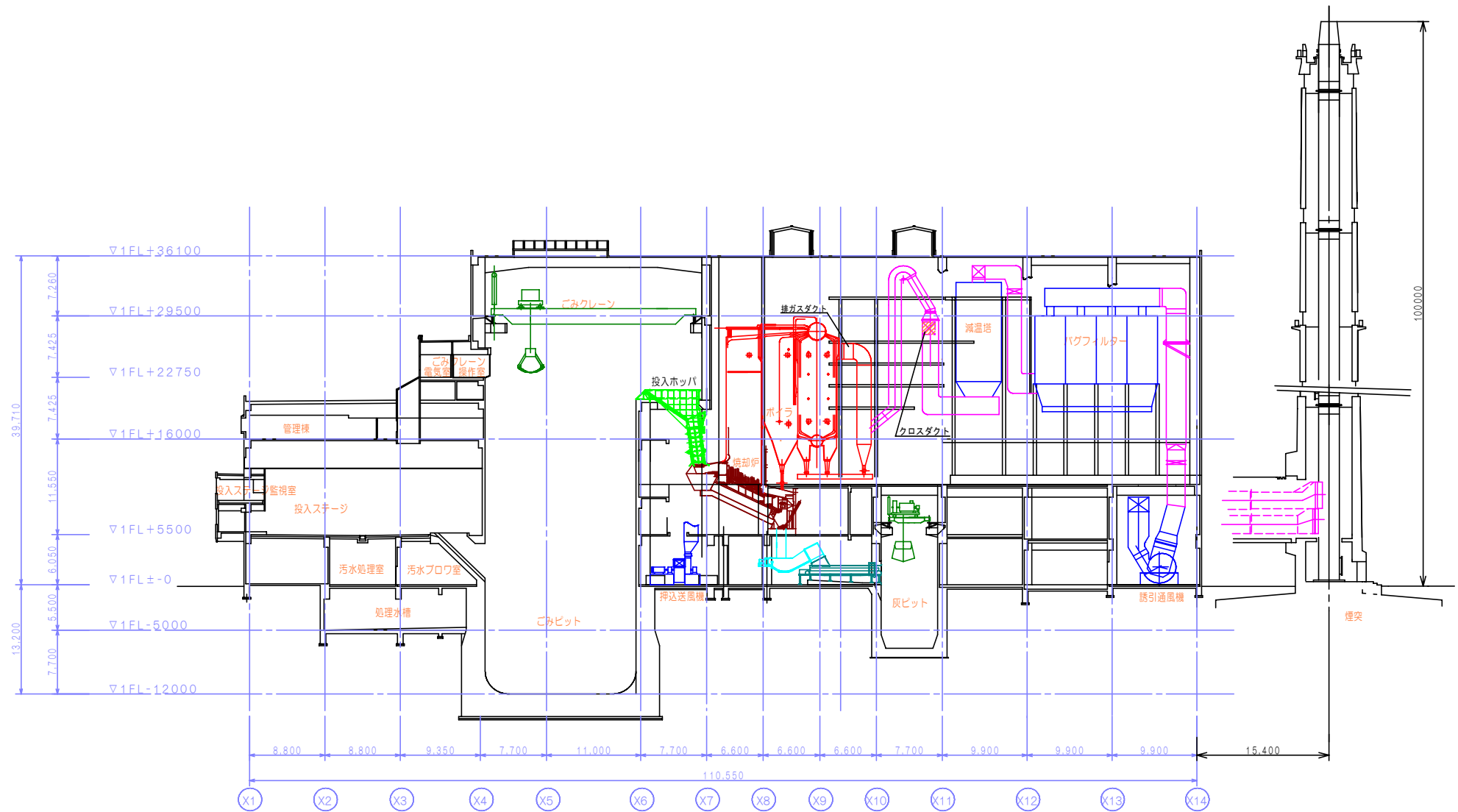

複写禁止

必要資材

#	品名	規格	数量	備考
①	土のう袋	-	100枚	

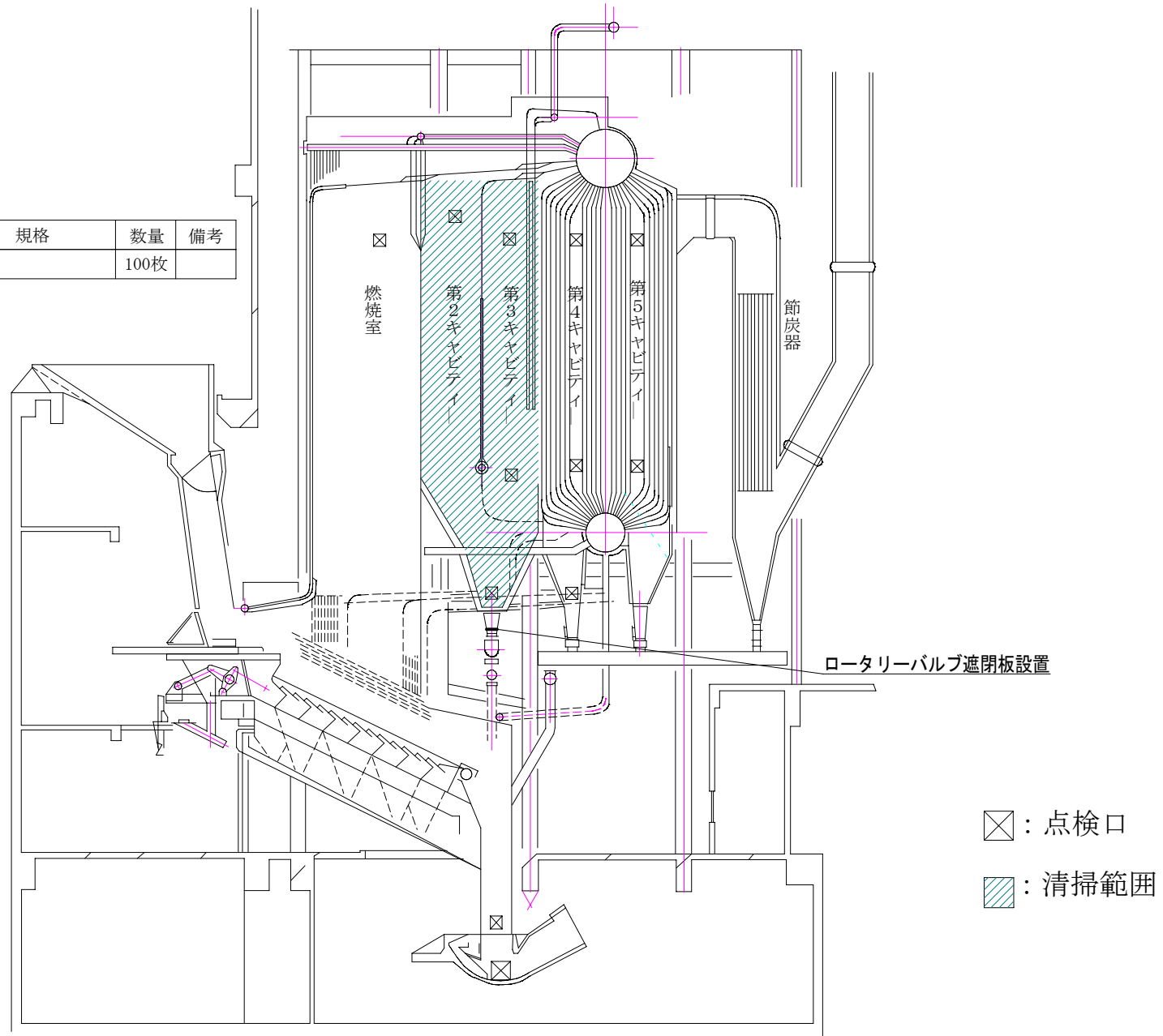

複写禁止

複写禁止

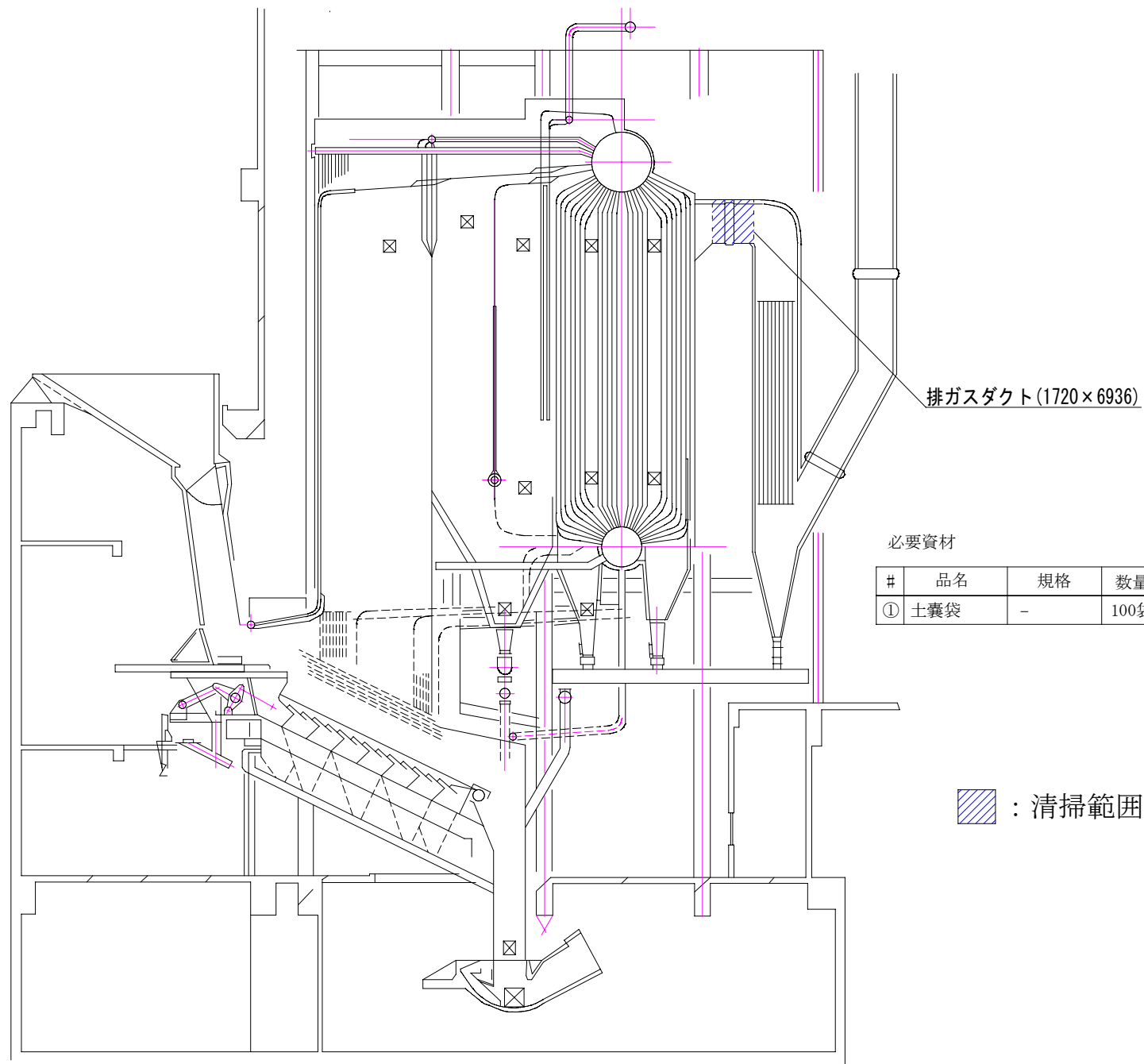

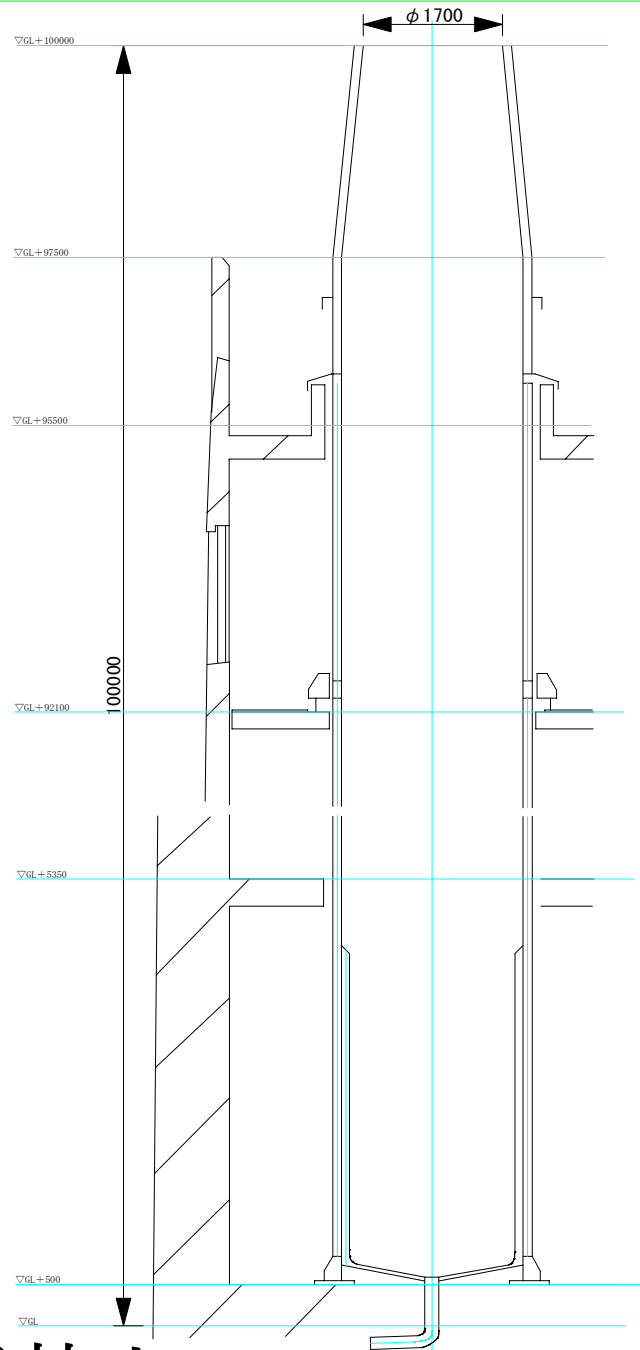

必要資材

#	品名	規格	数量	備考
①	煙突養生シート	-	1枚	支給

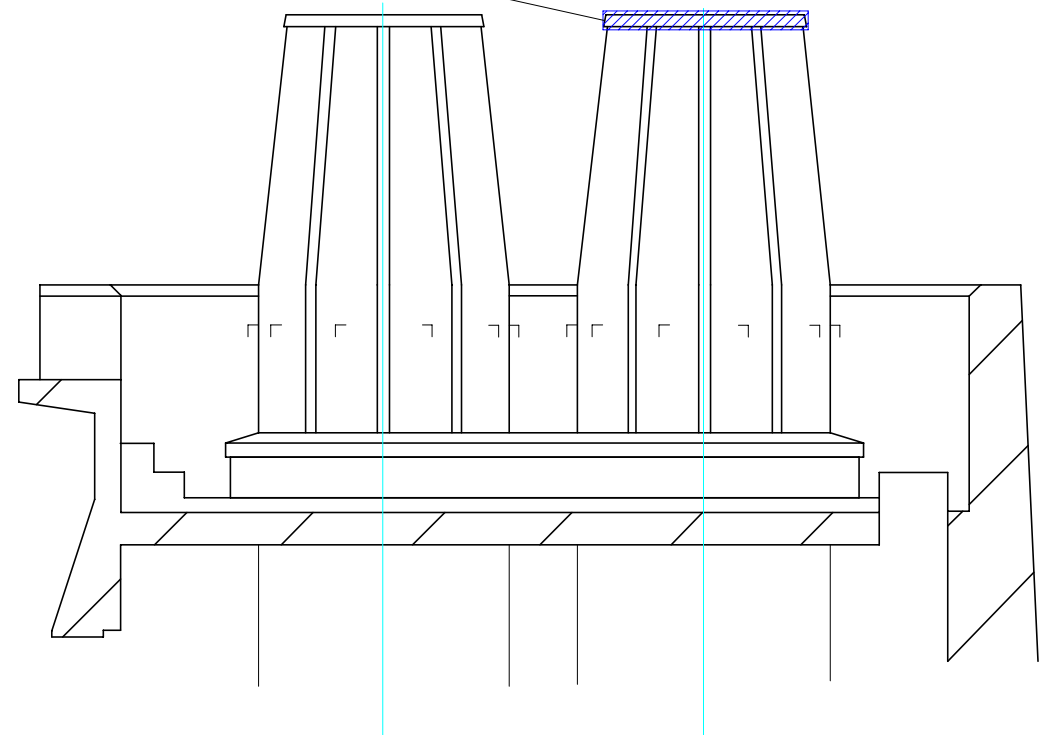
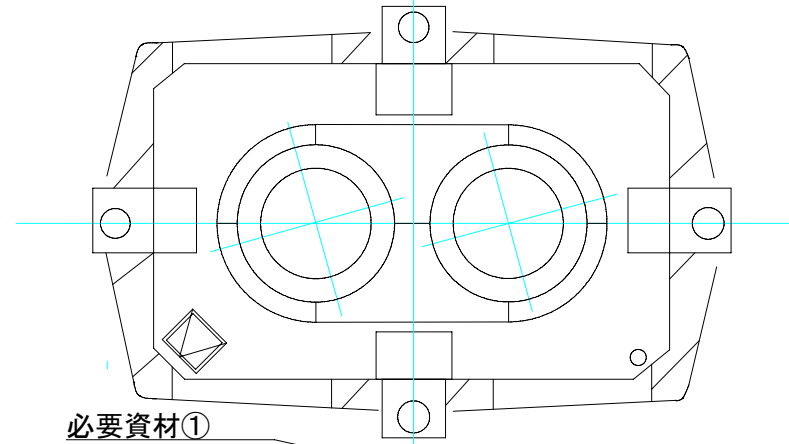

複写禁止

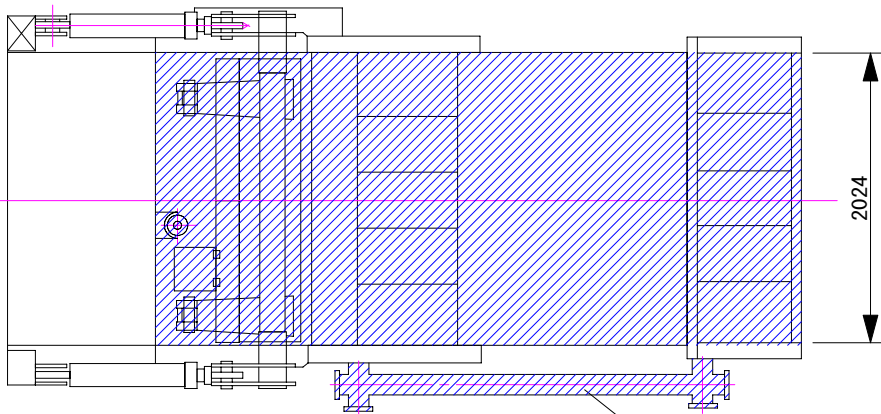

清掃体積
 $(0.857+2.075+2.142) \times 2.024 \times 1.11$
 $\div 11.39 \text{ m}^3$

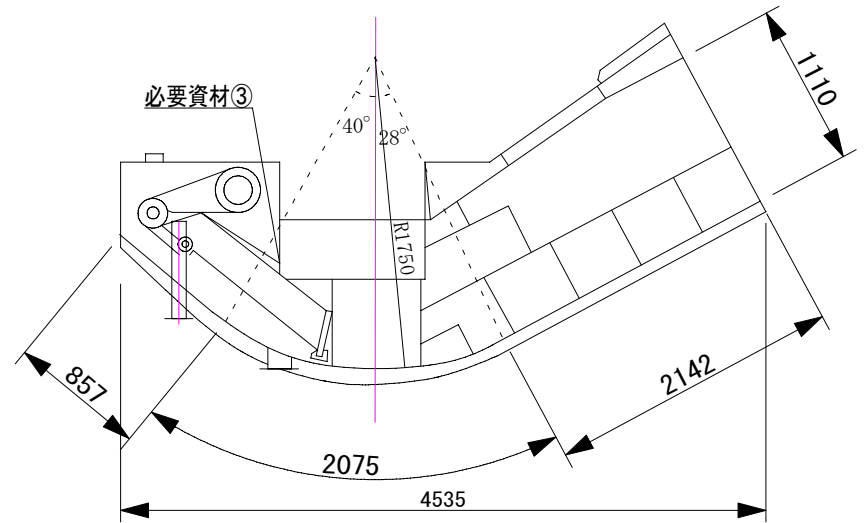
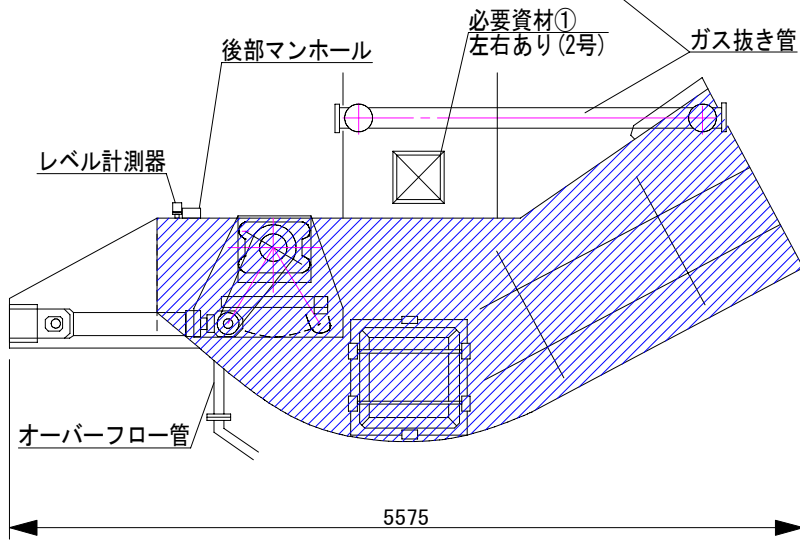

複写禁止

必要資材

#	品名	規格	数量	備考
①	マンホールガasket	T/1995 2.0t 550/500×470/420×B25	2枚	支給

 : 清掃範囲

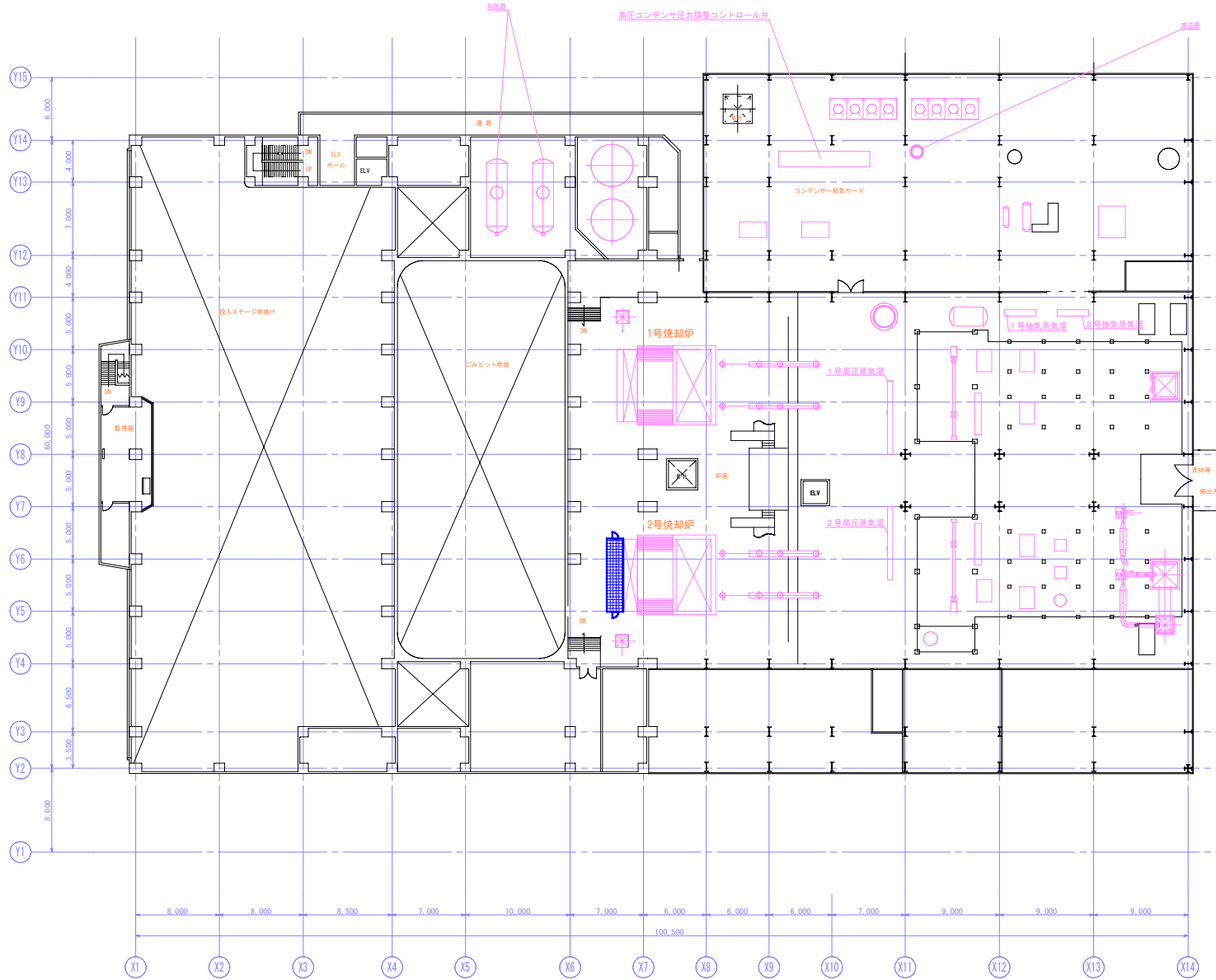
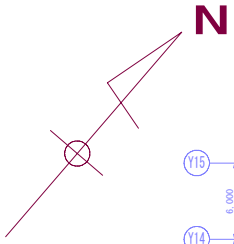

複写禁止

 : 飛散防止養生設置箇所(1号)

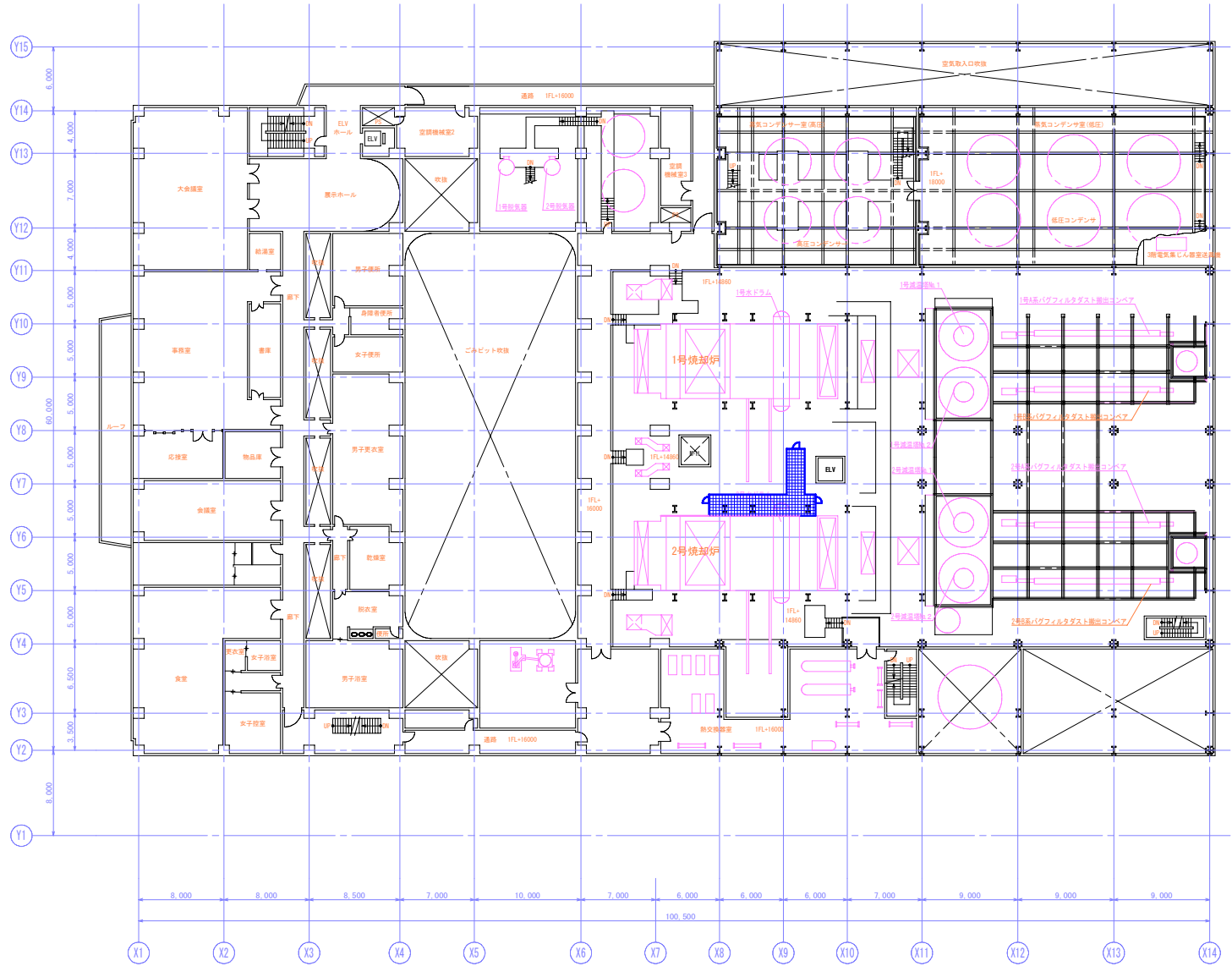
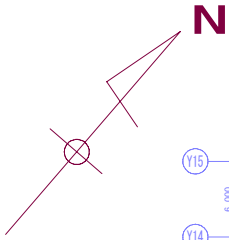

複写禁止

 : 飛散防止養生設置箇所(1号)

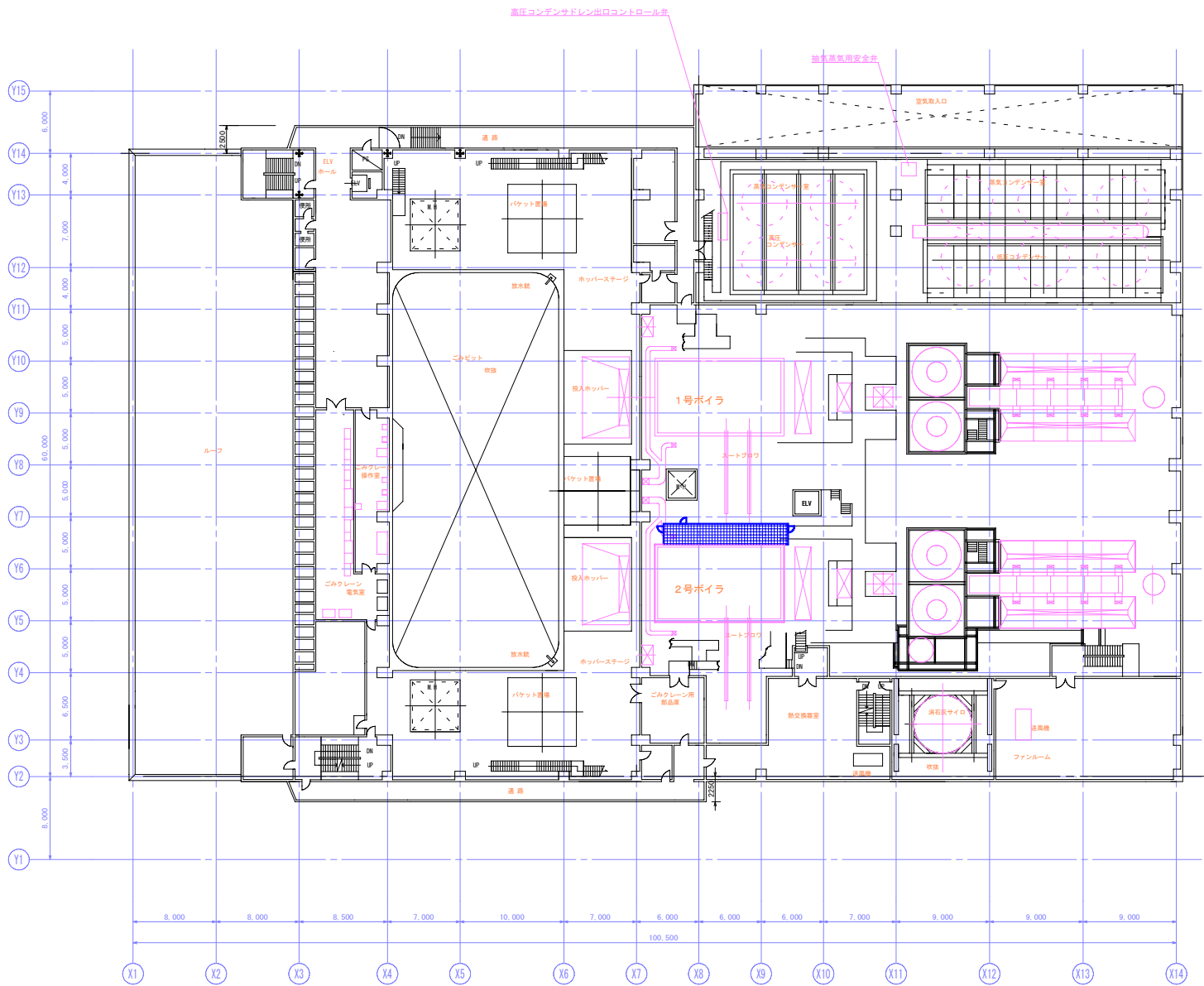
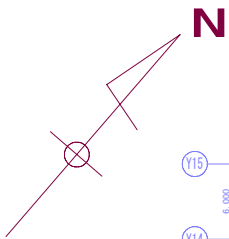

複写禁止

 : 飛散防止養生設置箇所(1号)